



ESTES INDUSTRIES  
1295 H STREET  
PENROSE, CO 81240 USA

# AMERICA™ STARTER SET

EST #1447

(7-94) 84078

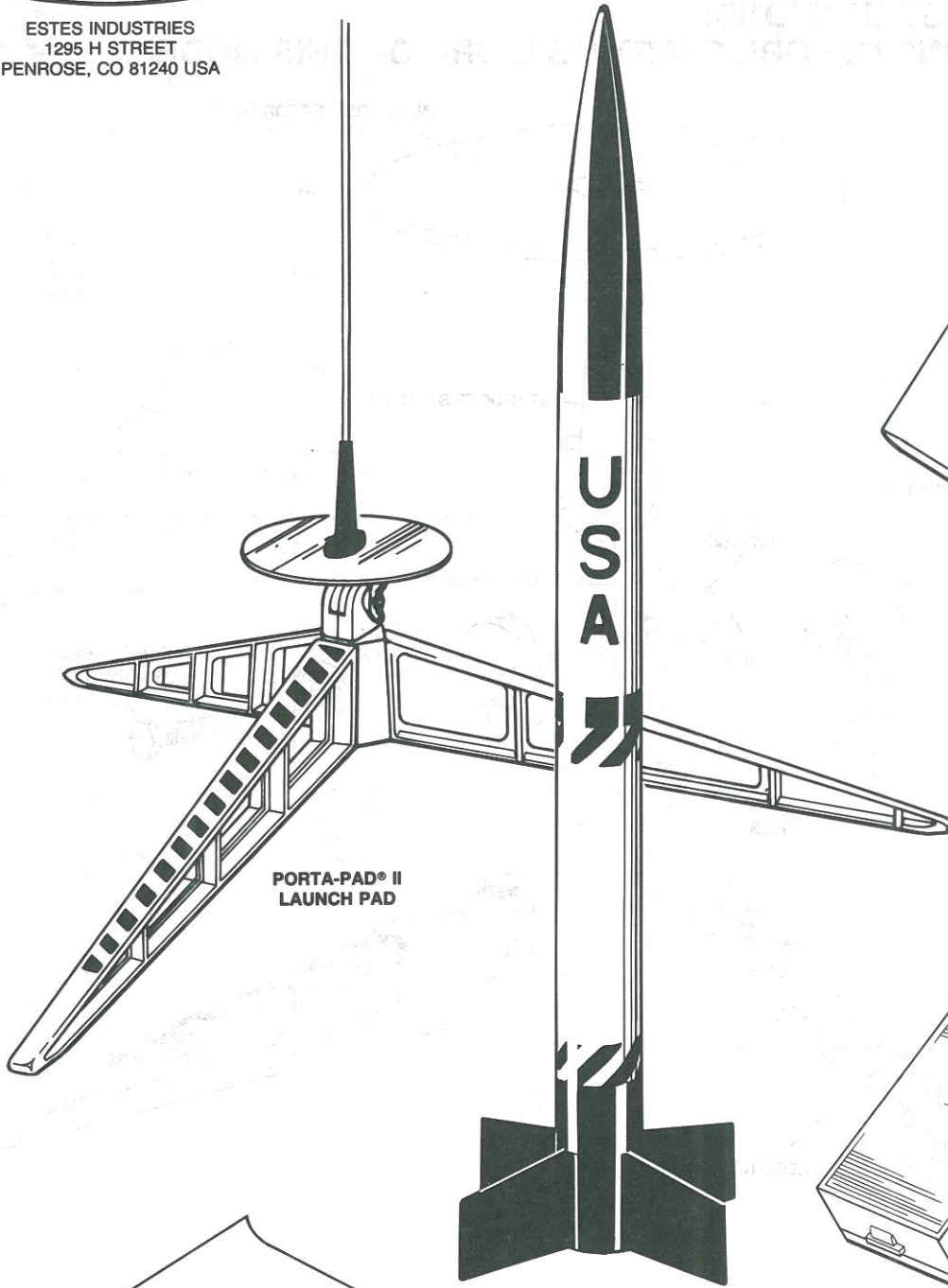

PORTA-PAD® II  
LAUNCH PAD

AMERICA™ ROCKET

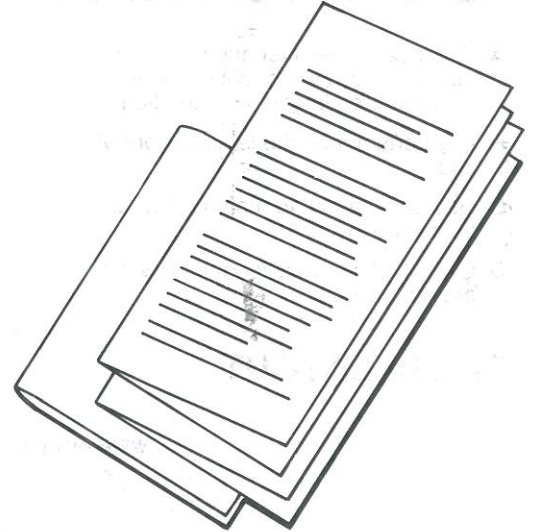

LITERATURE

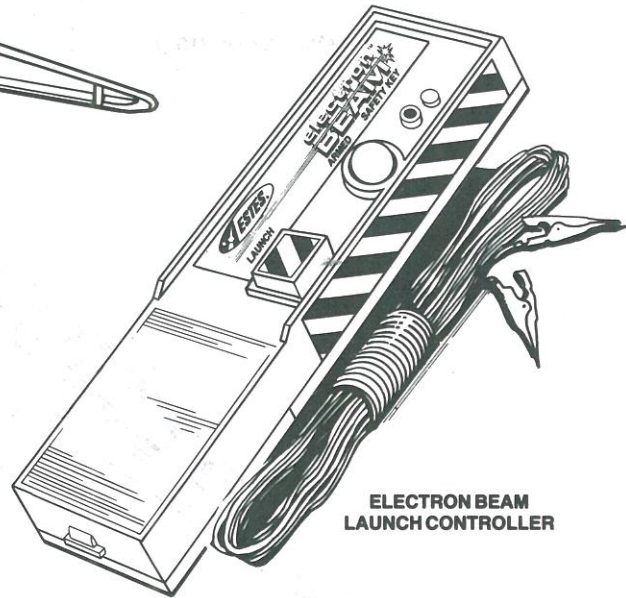

ELECTRON BEAM  
LAUNCH CONTROLLER

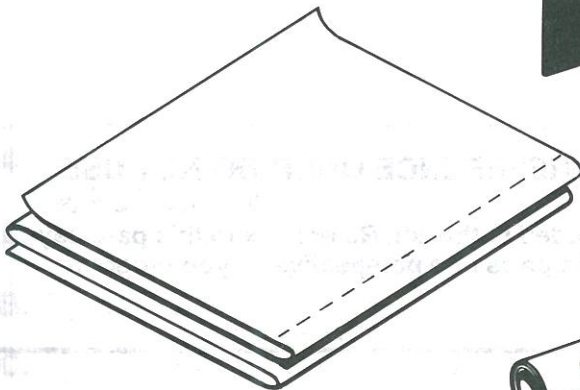

RECOVERY  
WADDING



IGNITER PLUGS

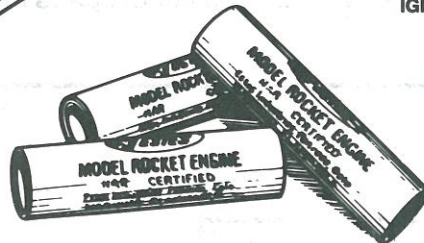

ROCKET  
ENGINES

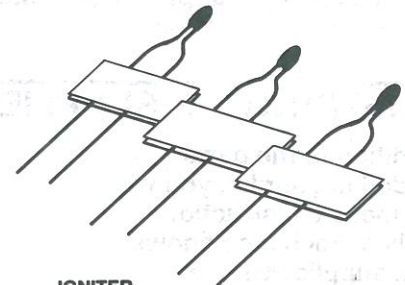

IGNITER  
PACK

## Part One: Launch Pad Assembly

### HOW TO USE THESE INSTRUCTIONS: READ ALL INSTRUCTIONS BEFORE STARTING WORK ON THIS MODEL.

- A. Read each step first and visualize the procedure thoroughly in your mind before starting construction.
- B. Lay parts out on the table in front of you.
- C. Use parts layout to match all parts contained in kit.
- D. Collect all construction supplies that are not included in the kit.

### PARTS LAYOUT

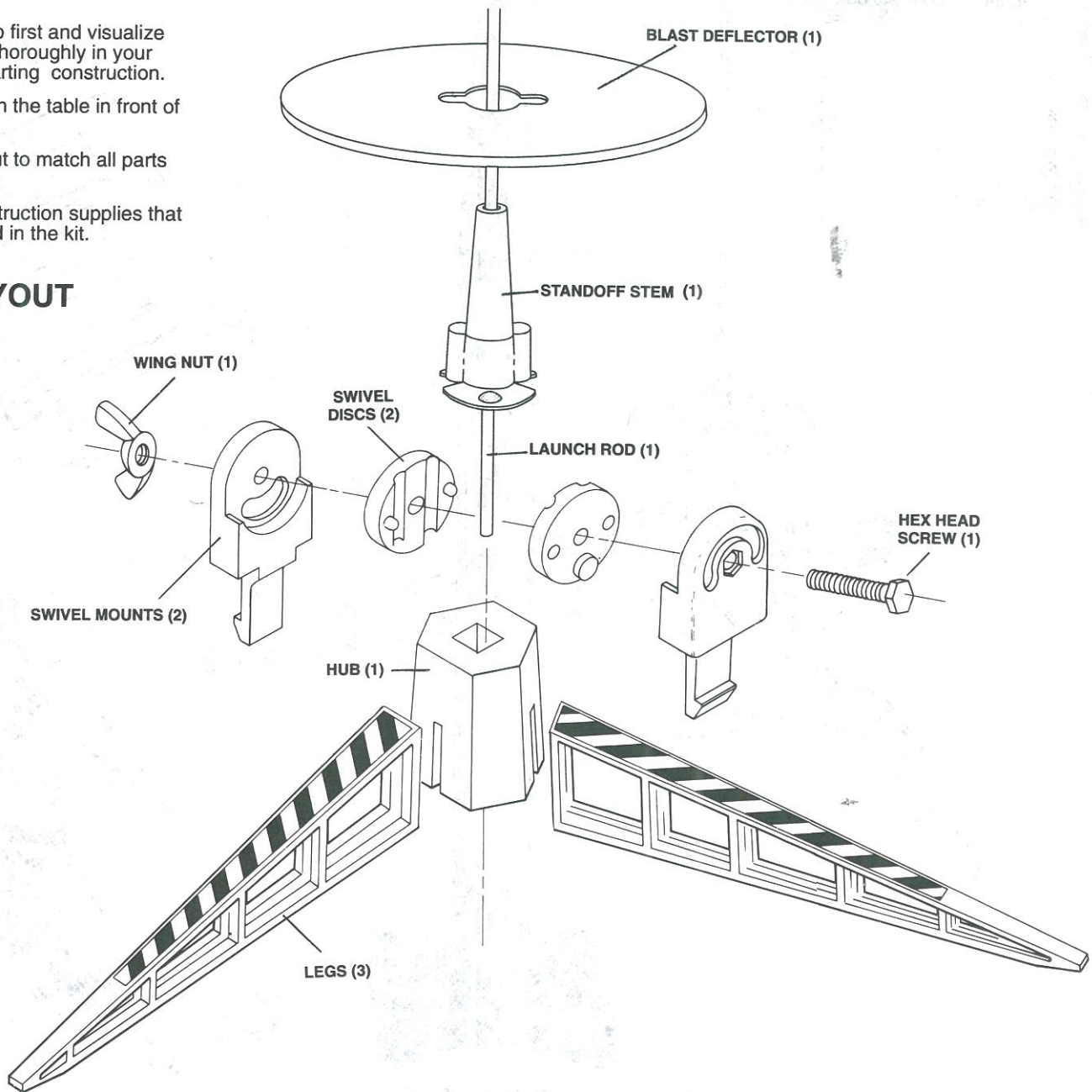

### EXTREMELY IMPORTANT: THE PARTS LAYOUT IS FOR REFERENCE ONLY! DO NOT USE THIS DRAWING ALONE.

The parts layout is only intended to assist you in locating the parts included in this kit. Refer back to this parts layout as you build your pad step by step. This method will help you put the parts into perspective as you progress through the construction.

### CONSTRUCTION SUPPLIES

In addition to the parts included in your kit, you will need these construction supplies. Each step shows which supplies will be required.



SCREWDRIVER



SANDPAPER