

PHASER

#1984



A DAMON COMPANY

ESTES INDUSTRIES
1295 H STREET
PENROSE, CO 81240 USA

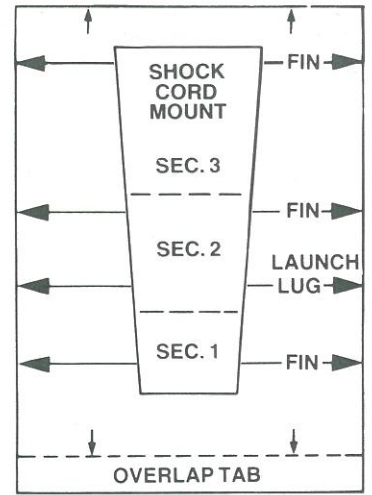
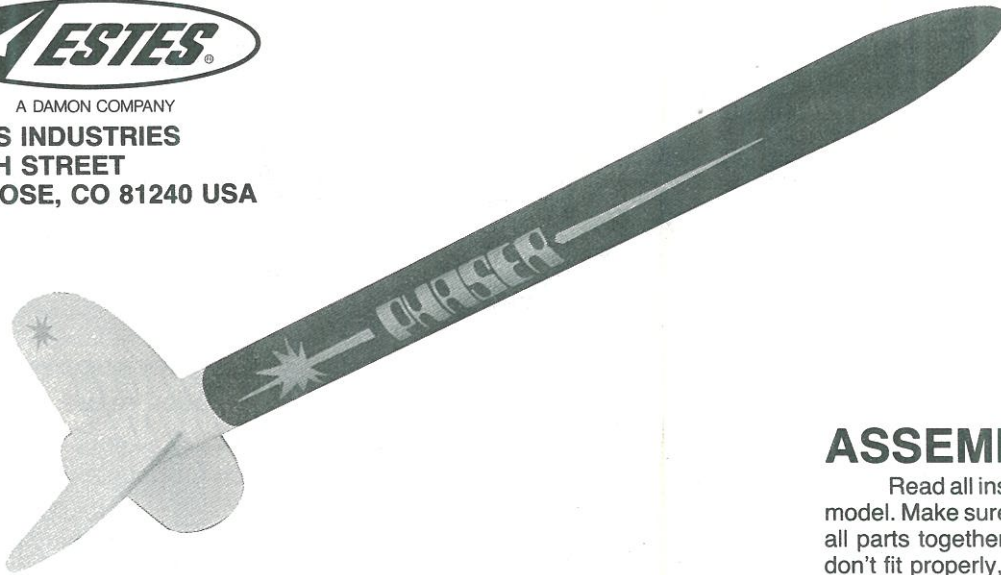

ASSEMBLY TIP

Read all instructions before beginning work on your model. Make sure you have all parts and supplies. Test-fit all parts together before applying any glue. If any parts don't fit properly, sand as required for precision assembly.

PARTS AND SUPPLIES

Locate the parts shown below and lay them out on the table in front of you. In addition to the parts included in the kit you will also need:

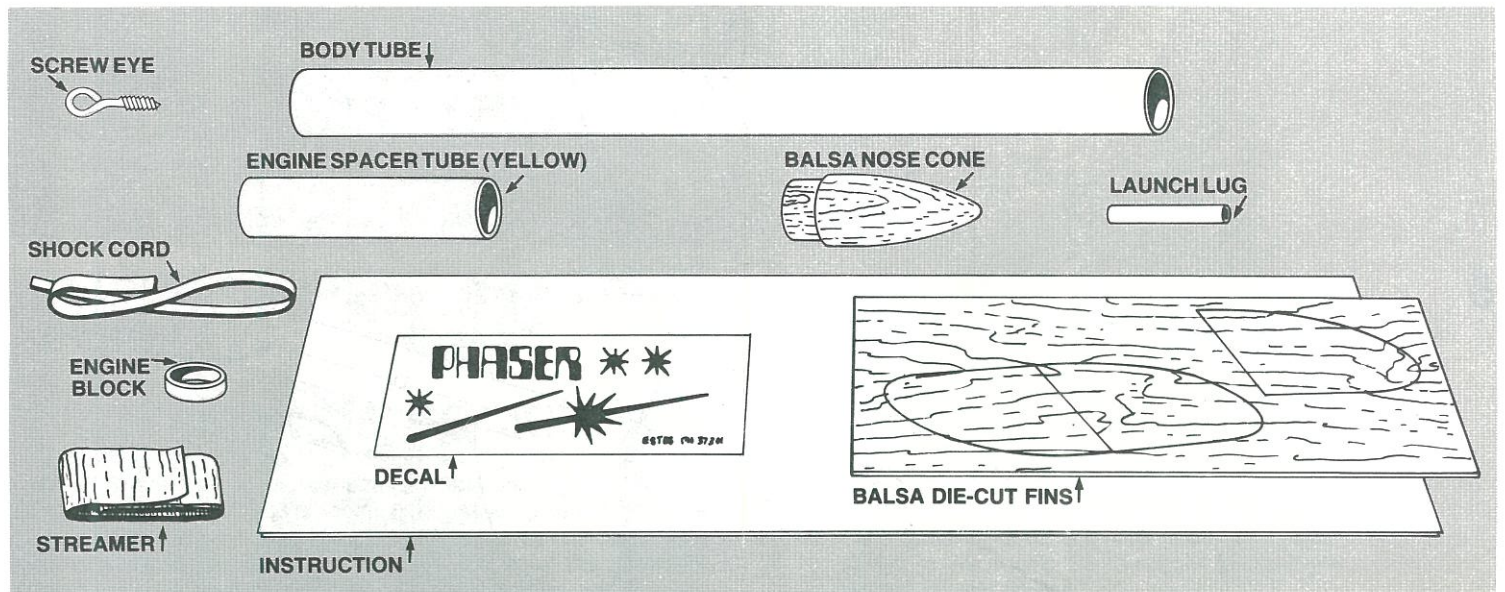
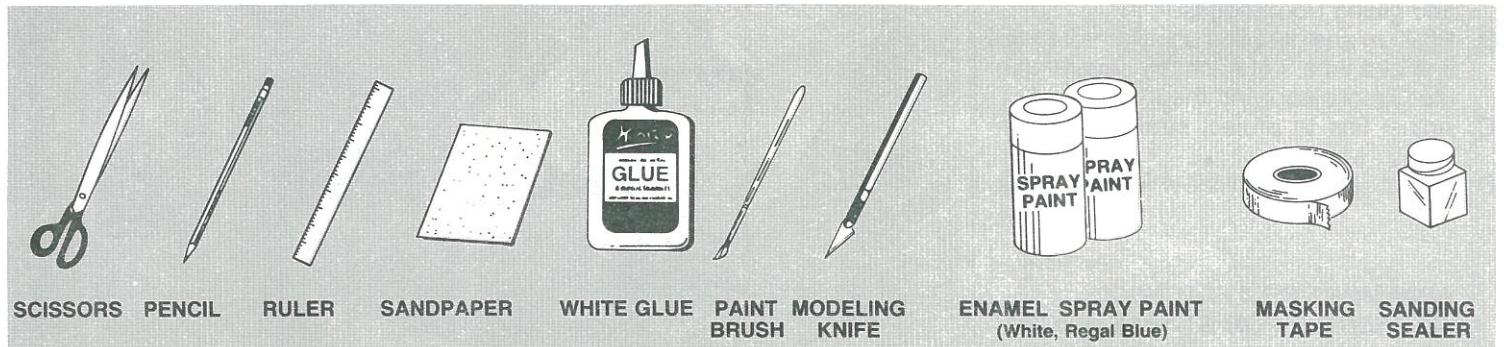

ROCKET ASSEMBLY

1

- Mark spacer tube 1/4 inch from one end.
- Using a piece of scrap balsa, smear glue inside body tube 2 inches from one end.
- Push engine block up into body tube with spacer tube until 1/4 inch mark is even with end of body tube and remove spacer tube immediately.

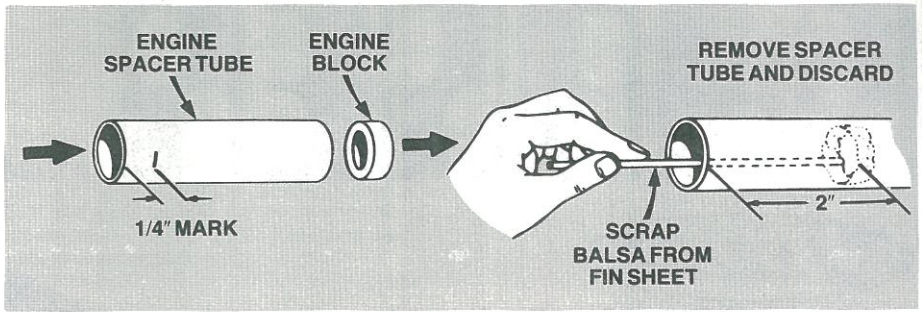

2

- Fine sand balsa die-cut sheet. Carefully remove fins by freeing edges with sharp knife.
- Stack fins together. Sand all edges smooth.

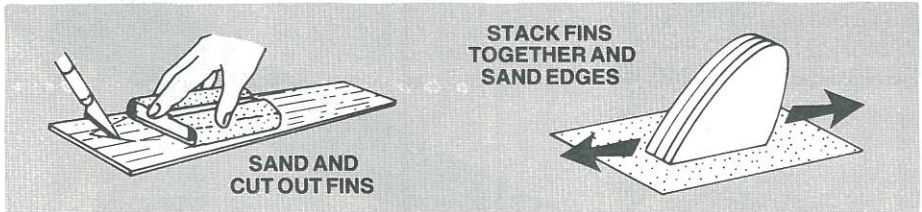

3

- Cut out tube marking guide from front of instructions.
- Wrap guide around the tube and mark tube at arrows. Mark launch lug line.
- Remove guide and save.
- Draw straight lines connecting each pair of marks. Extend all lines 3 inches up tube.

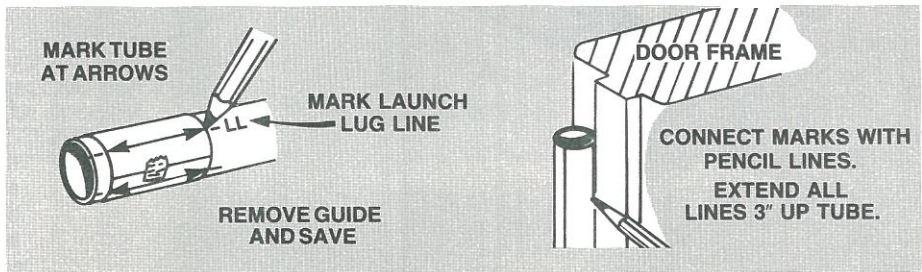

4

- Lay fins on pattern to find front (leading) and gluing (root) edges.
- Position and glue fins on alignment lines one at a time. Let each dry several minutes before applying the next one.
- Adjust fins to project straight out from tube.
- Do not set rocket on fins while glue is wet.

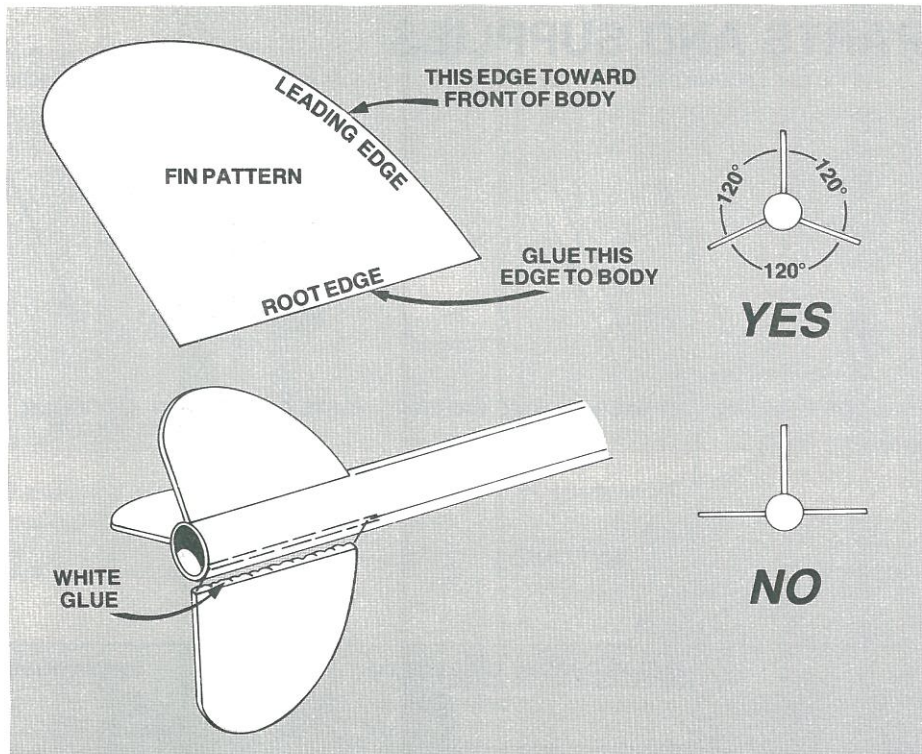

FINS MUST BE ATTACHED CORRECTLY FOR STABLE FLIGHT!

5

- Glue launch lug on launch lug line even with end of body tube.

